

DIY2408 Shirt jacket #MetteShirtJacket

Seam allowance is included on all patterns:
 Center front 1+6 cm
 Hem line 1+5.5 cm
 Sleeve hem 1+5.5 cm
 All other seams 1 cm

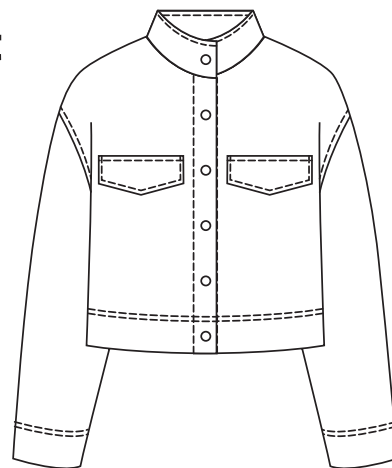

You need to cut the following parts

Fabric

Part 1	Front	x 2
Part 2	Back	x 1
Part 3	Sleeve	x 2
Part 4	Collar	x 2
Part 5	Pocket flap	x 4

Interlining

Part 1	Front	x 2
Part 4	Collar	x 1
Part 5	Pocket flap	x 2

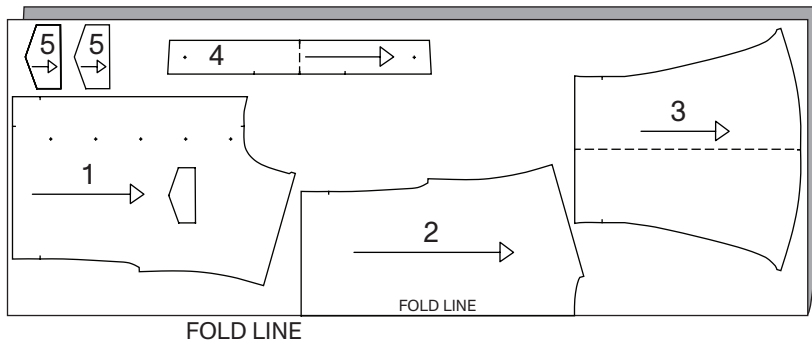

You need the following fabric and accessories

Size		XS	S	M	L	XL	
Fabric:	w/135 cm	190	190	190	195	195	cm
Interlining:	w/90 cm	60	60	60	60	60	cm

Accessories:
 6 x Button

Pick your size

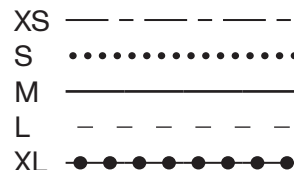

Symbols you may find on your patterns

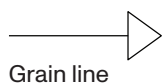

Grain line

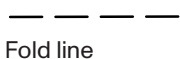

Fold line

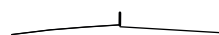

Notch



Gathering



Interlining



Cut line

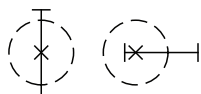

Placement of button and buttonhole

10 CM

10 CM

Self made®

CONTROL SQUARE:
 Print this page, to check the square measurements:
 If the measurements do not match, please adjust your printer settings.

▲ Unsure how to print? See this guide

CONTROL PAGE FIT:
 In print preview check page margin.
 Margin have to be equal on all 4 sides of each page.

X

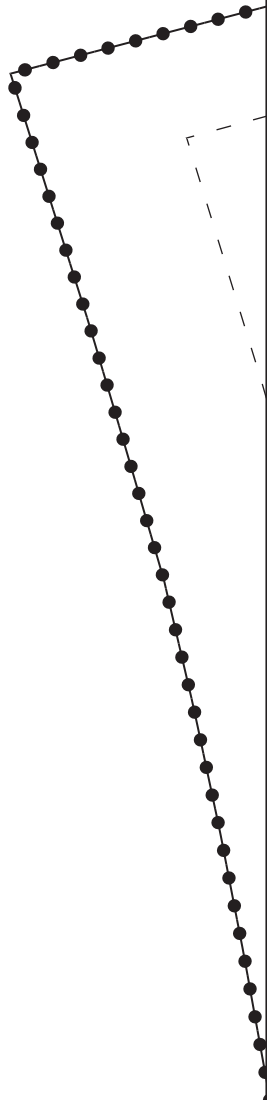
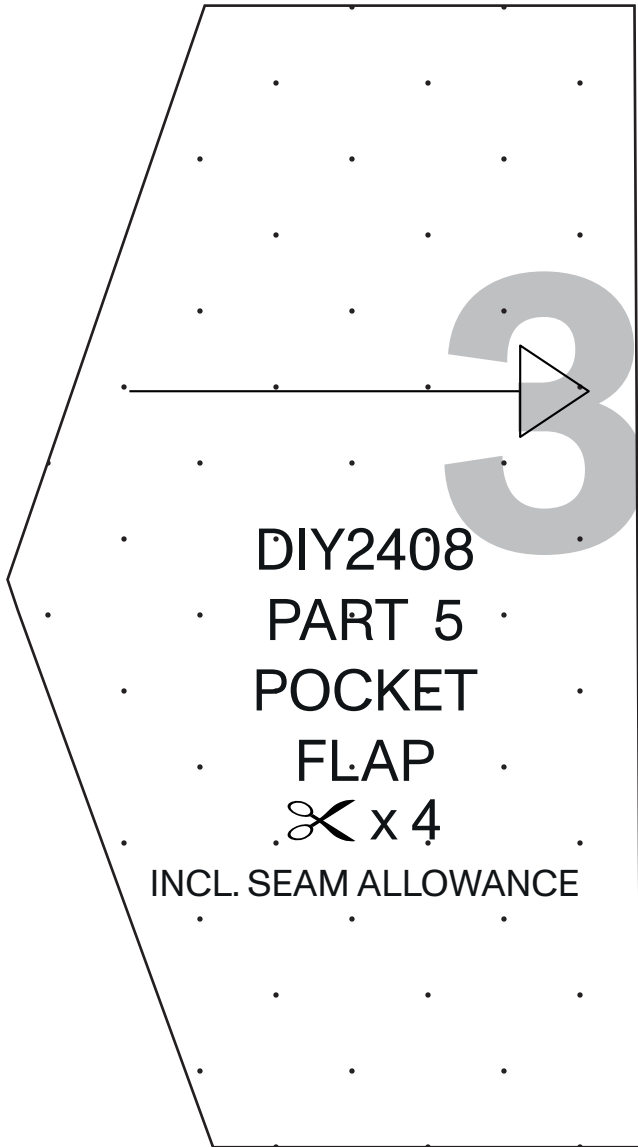

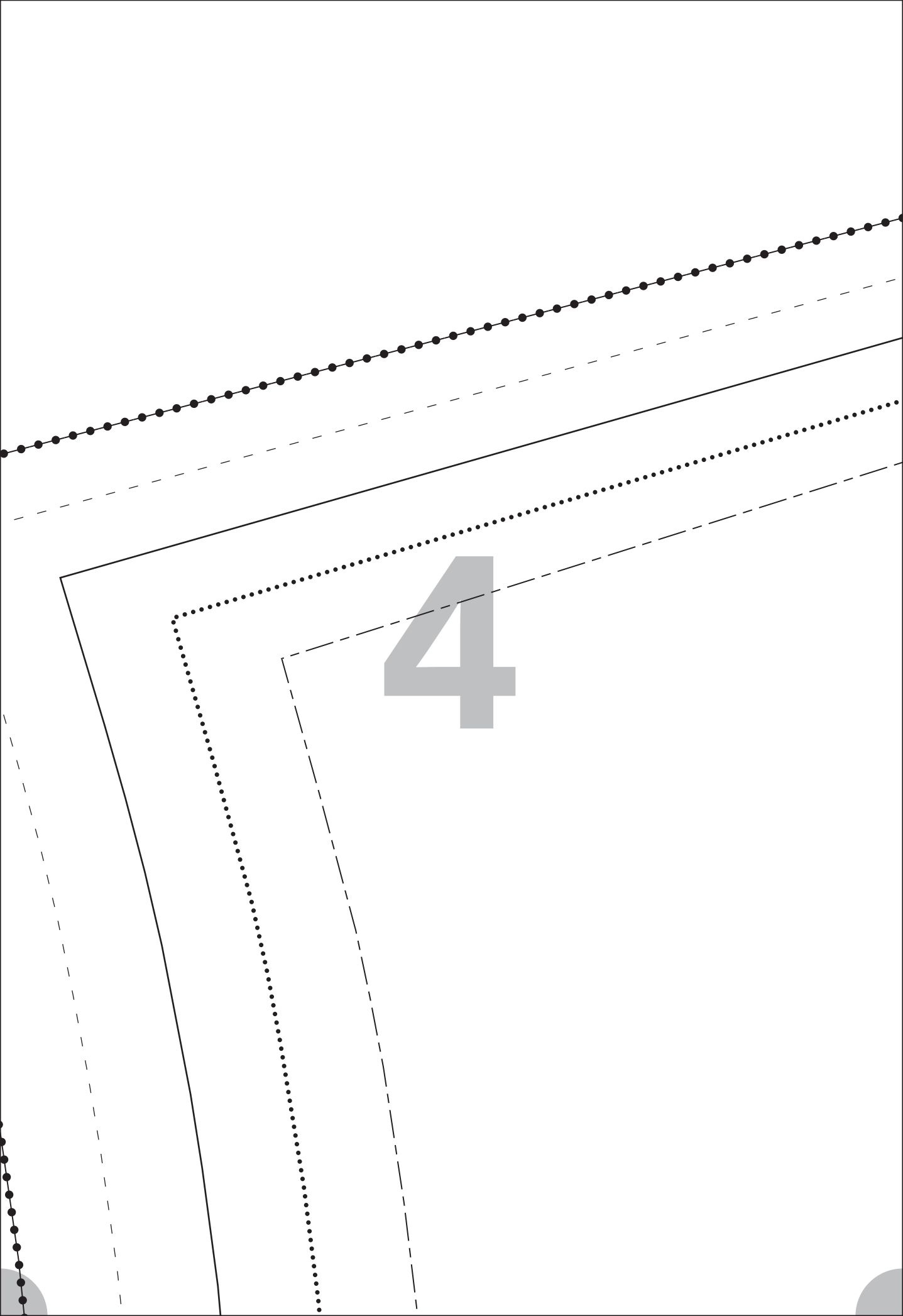

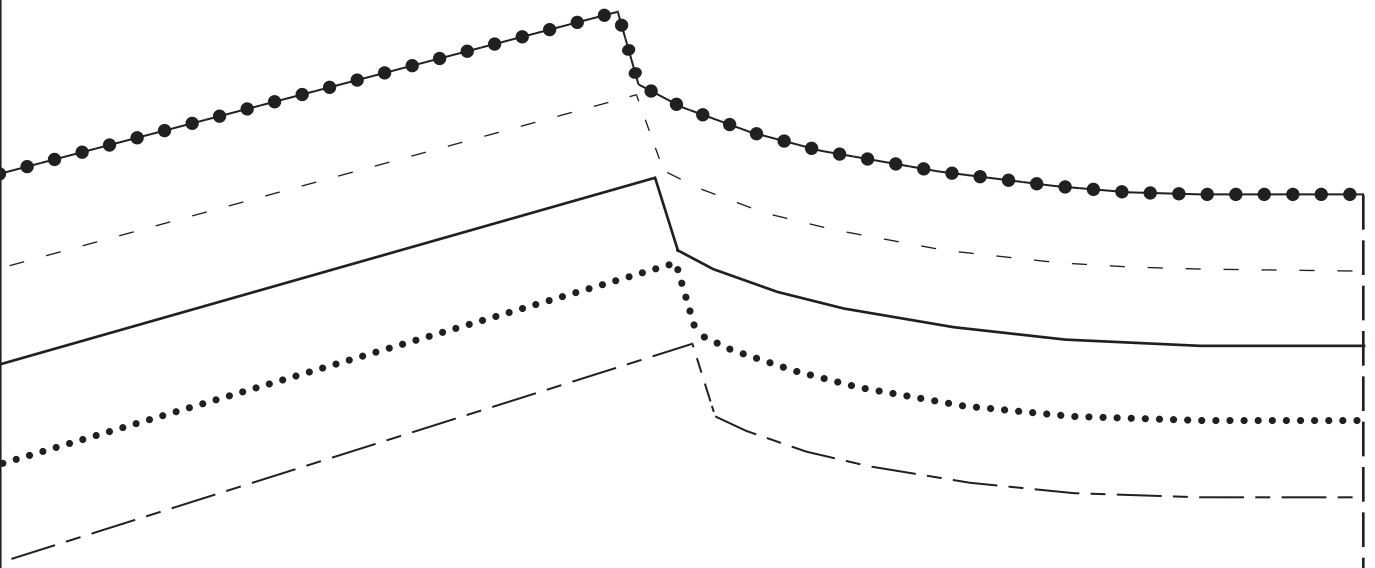

5



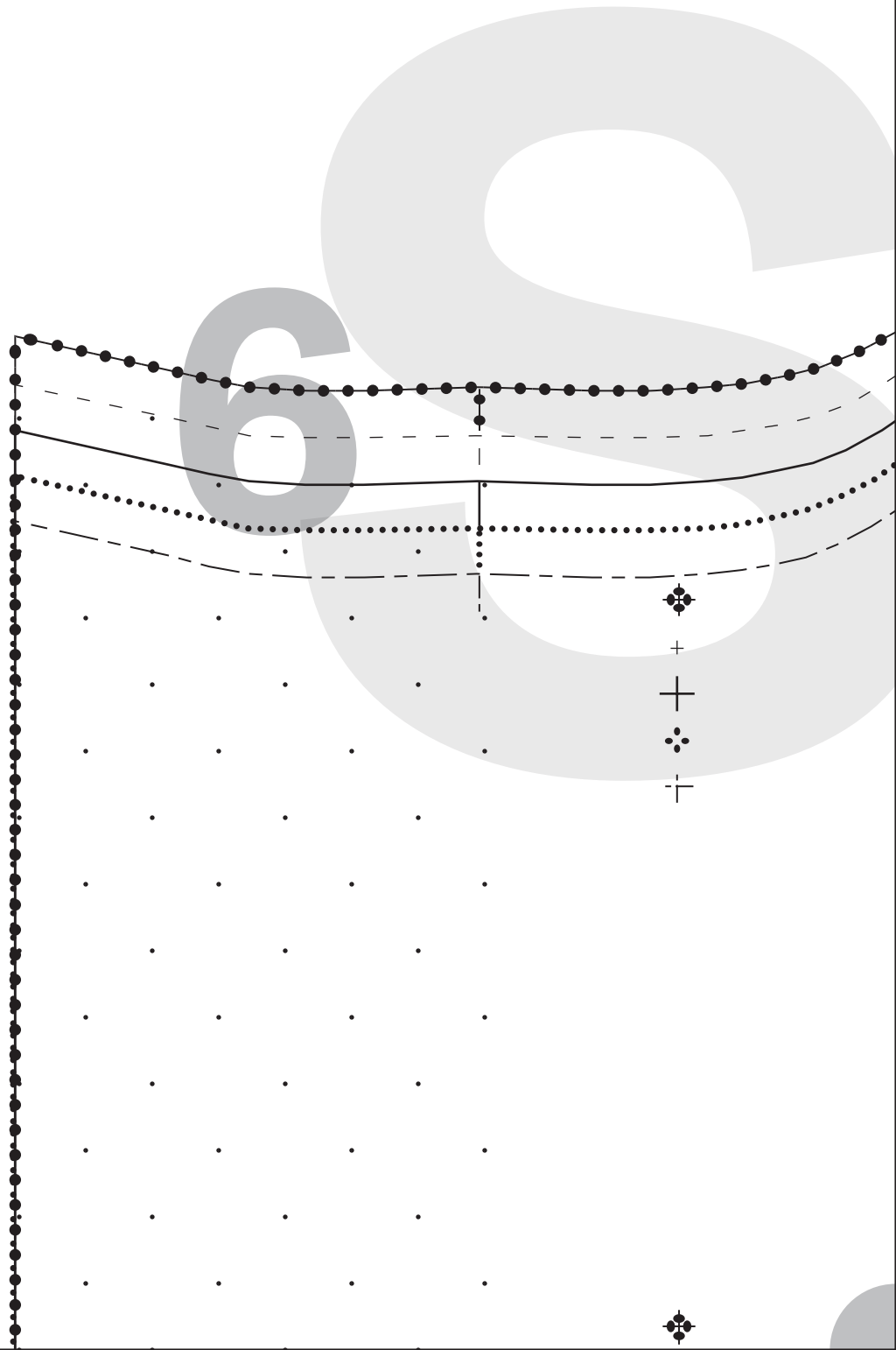



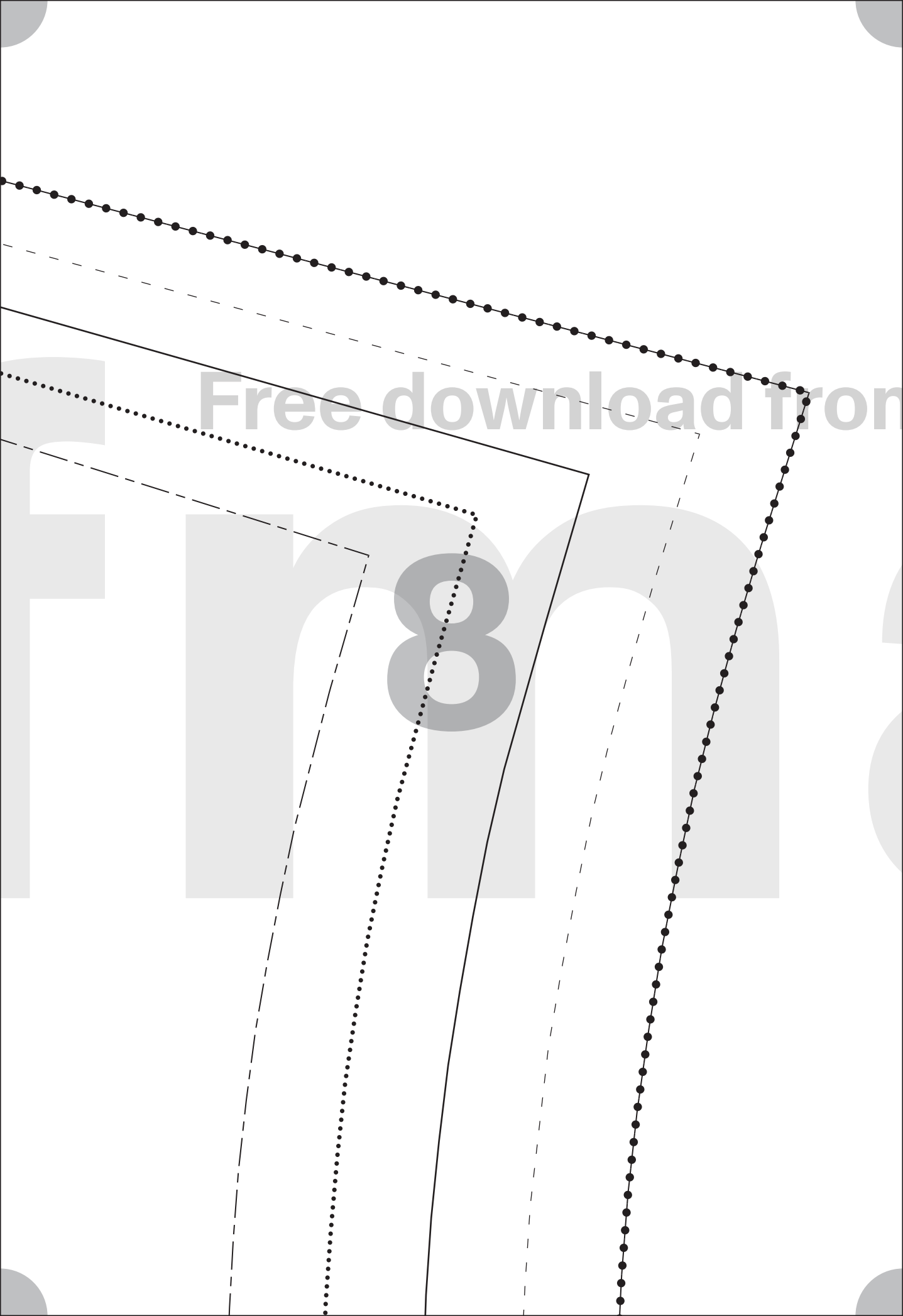

n Selfmade.com

Handwriting practice sheet for the word "road". The word is shown in a large, light gray font. A solid black line traces the outline of the word. A dotted line follows the solid line, and a dashed line is positioned to the right of the dotted line, serving as a guide for letter height and placement. The word "road" is written in a simple, sans-serif font.

DIY2408
PART 2
BACK



x1

INCL. SEAM ALLOWANCE

Q10[®]

FOLD LINE



11

S



**Self
made[®]**

**DIY2408
PART 1
FRONT**



x 2

INCL. SEAM ALLOWANCE

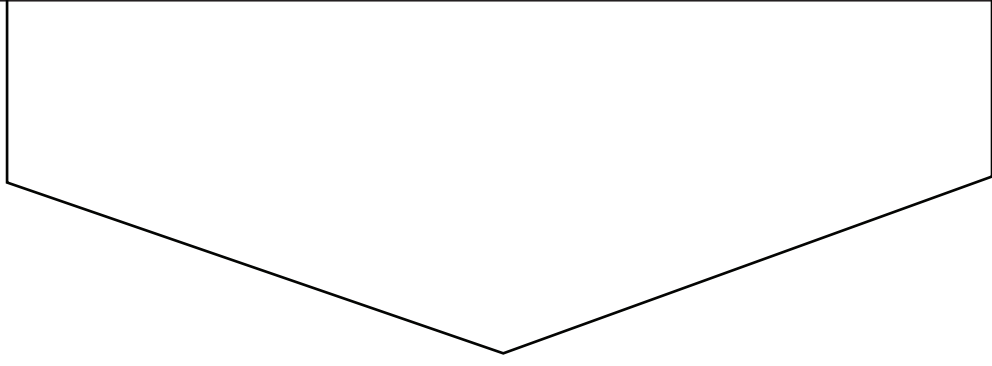

Free download from

F

13

n Selfmade.com

2014

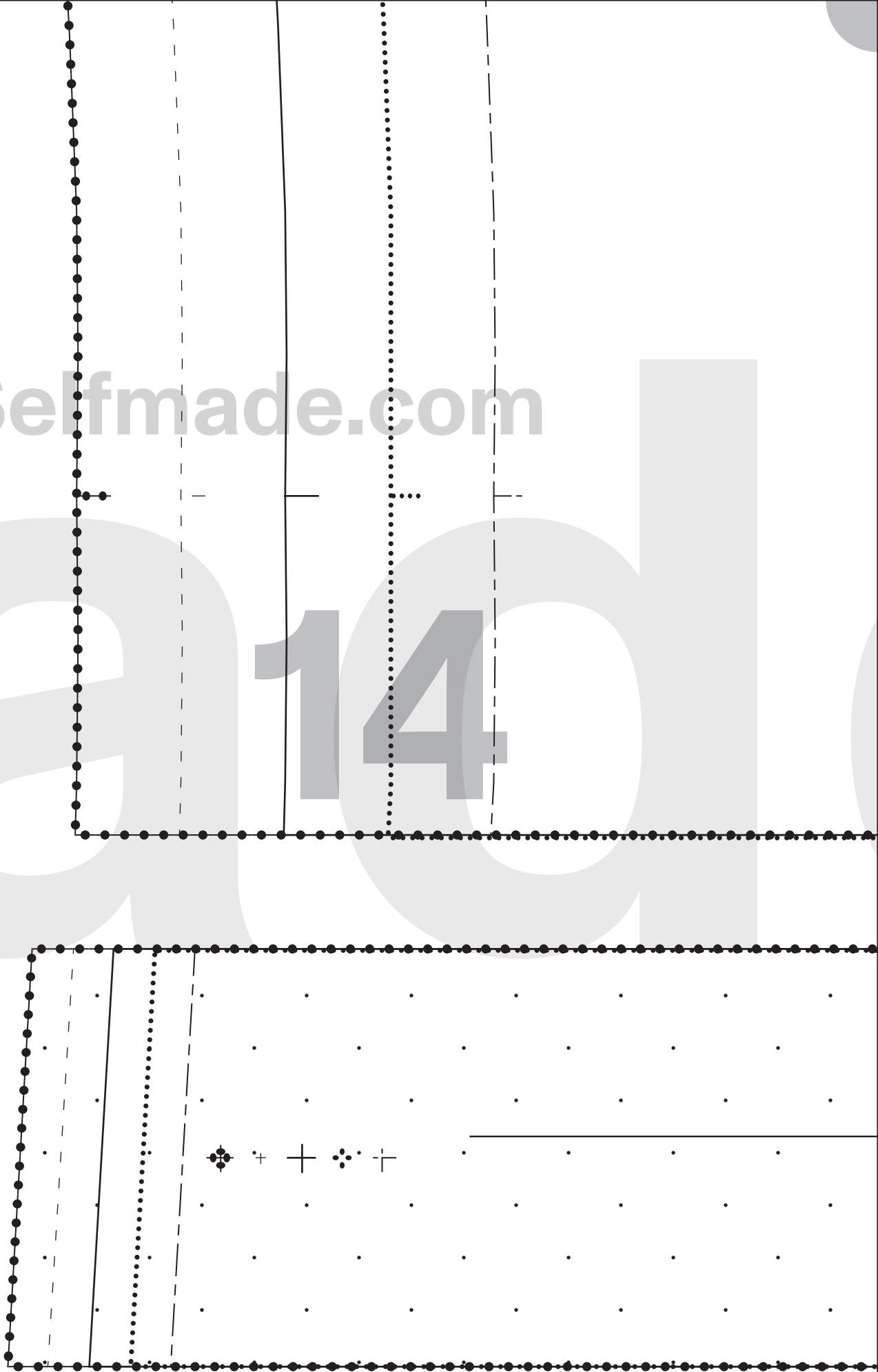

e[®]15

DIY2408

PART 4

COLLAR

✂ x 2

INCL. SEAM ALLOWANCE

FOLD LINE

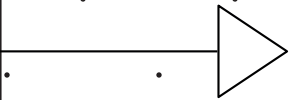

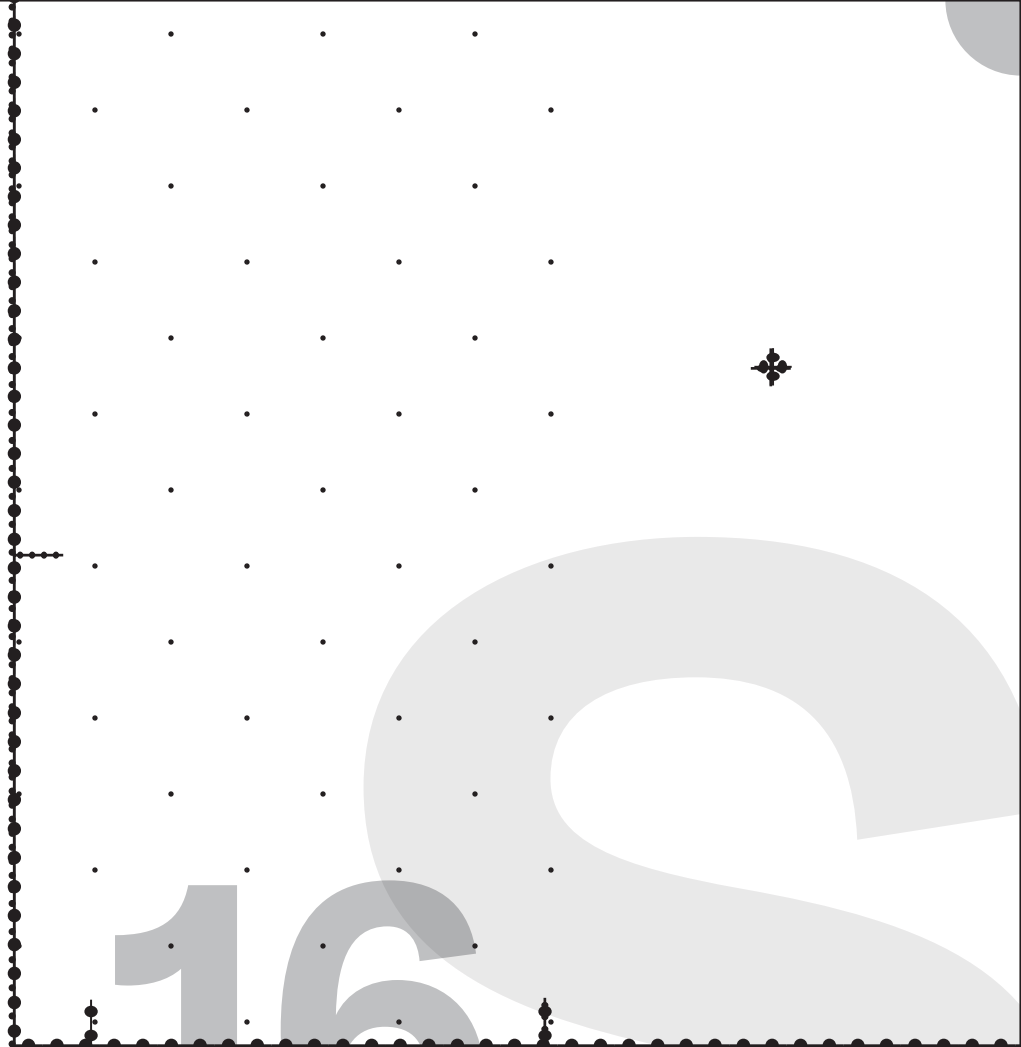

16

S

e17

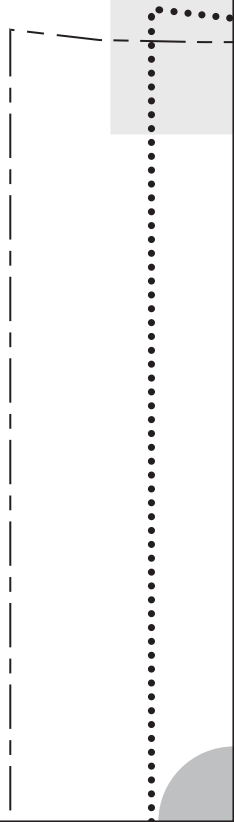

Free download from

18

on Selfmade.com

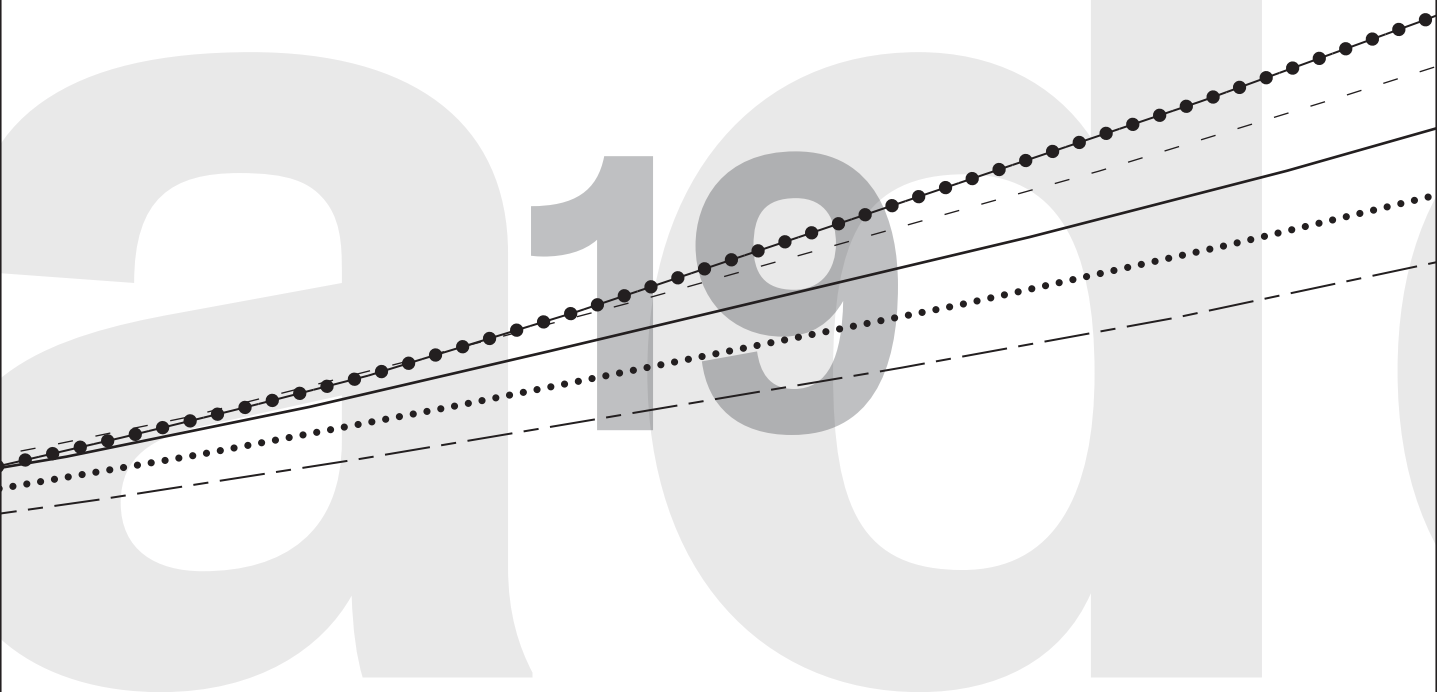

DIY2408

PART 3

SLEEVE

✂ x 2

INCL. SEAM ALLOWANCE

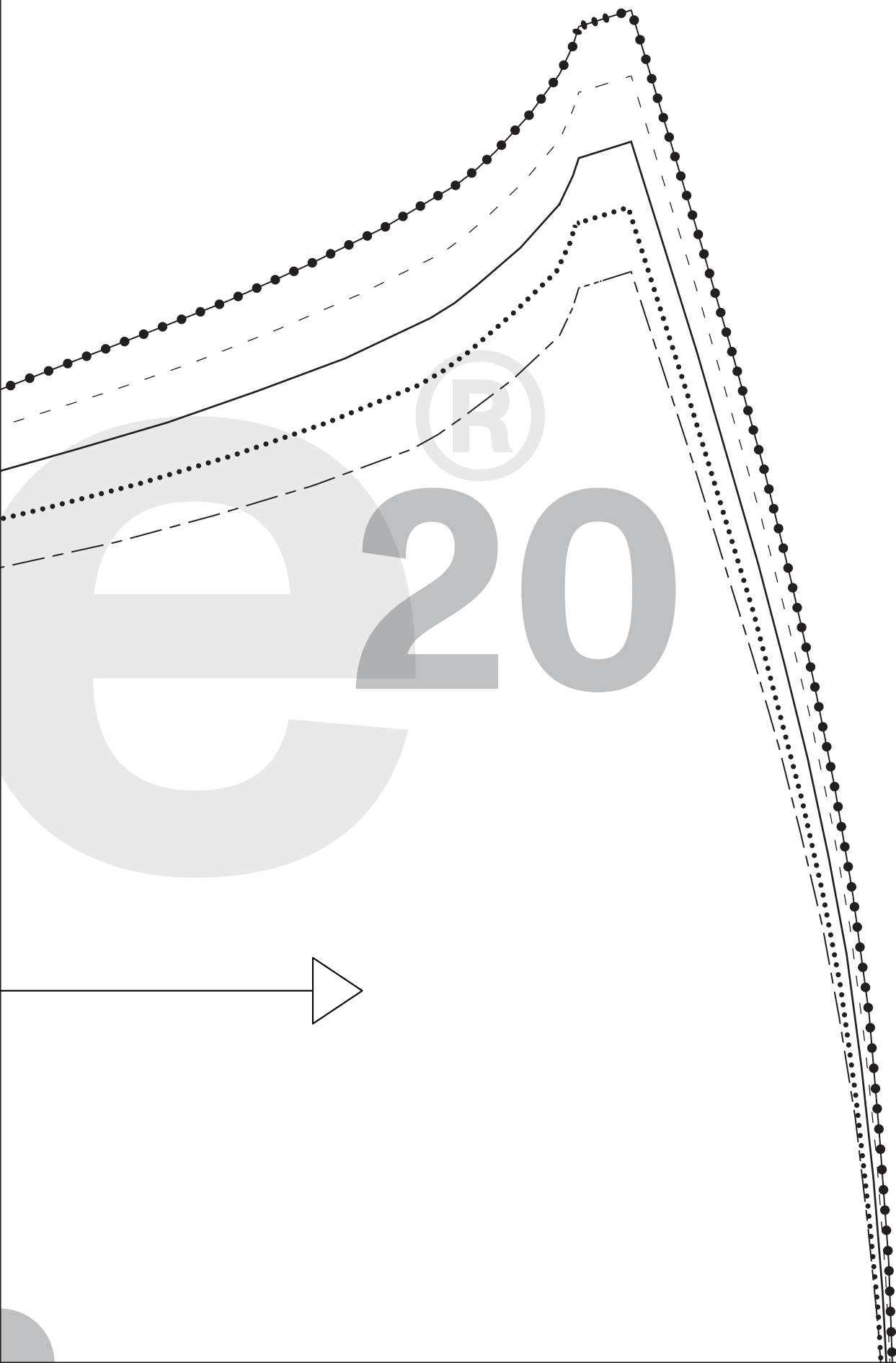

21S

2022

Free download from

23

FOLD LINE

n Selfmade.com

24

e[®]25